



**smart
vatten®**

**VERTO
VERTOBLUE
INSTALLATION INSTRUCTION**

03/06/2025

Contents

- 1. Important note for the installation technician.....3**
- 2. Installation instructions..... 4**
 - 2.1. Installing the flow sensor..... 4
 - 2.2. Installing the collection unit..... 4
 - 2.3. Connecting the impulse sensors to the collection unit (optional)..... 5
 - 2.4. Installing the household unit..... 5
 - 2.5. Connecting the flow sensors to the household unit.....6
 - 2.6. Installing the unit display.....8
- 3. After the installation..... 11**
 - 3.1. Commissioning inspection.....11
 - 3.2. Service.....11
 - 3.3. Warranty..... 11
 - 3.4. Recycling.....11
- 4. Technical details..... 12**
 - 4.1. Household unit..... 12
 - 4.2. Unit display..... 12
 - 4.3. Flow sensor.....13
 - 4.4. Collection unit..... 15

1 IMPORTANT NOTE FOR THE INSTALLATION TECHNICIAN



NOTE When installing the sensors, only use the 3-mm seals that come with the sensor.



Install the sensors only by tightening the connectors. The torque for tightening the sensor's connectors is 10–12 Nm.



Note that the body may only be seized with a tool at the place marked with an 'x' (28 mm width of jaw opening).

These installation and user instructions can also be viewed by reading the QR code on the sensor.

2 INSTALLATION INSTRUCTIONS

2.1 Installing the flow sensor

These installation instructions can also be viewed by reading the QR code on the sensor.

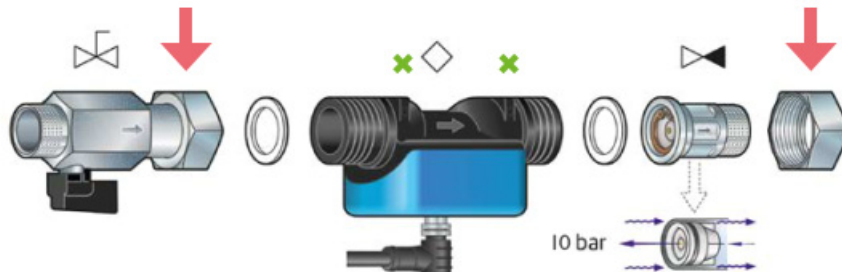

1. Install the flow sensors into a horizontal or vertical pipe paying attention to the flow direction indication arrow on the sensor body.
The flow sensors come factory-equipped with a laminar flow equalizer. If you remove the laminar flow equalizer, install a straight cable section of 200 mm before the flow sensor.
2. Place the flow sensors (total length 196 mm) so that they are easy to service. Make sure that their installation must meet the regulations for fire safety and electrical installations.
3. If you place the devices inside a casing or suspended ceiling, install a service hatch measuring at least 500 x 500 mm in the location of the devices.
4. When installing the sensors, only use the 3 mm seals that come with the sensor.
5. Install the sensors only by tightening the connectors. The torque for tightening the sensor's connectors is 10–12 Nm.
Note that the body may only be seized with a tool at the place marked with an 'x' (28 mm width of jaw opening).
6. Install the stop valve immediately before the flow sensor.
7. Do not install hot water circulation between the stop valve and the sensor body.

2.2 Installing the collection unit

Always install the collection unit before the household units.

The collection unit needs a 230V electrical socket (can be freely placed in the property).

If the collection unit is read remotely via a Ethernet connection (TCP/IP), a data socket for an RJ45 network cable is required.

The electrical contractor must ensure that the cables are suitable for the building/apartment and meet the regulations for fire safety and electrical installations.

1. Install the collection unit in the main electrical cabinet or other suitable location. Make sure that it is in the range of the radio network and mobile network.
2. Do not install the collection unit side by side with strong current cables.
3. Connect the collection unit into a protective earthed fixed socket-outlet with a power source that is included in the device delivery.
4. Fix the collection unit with screws.
5. After installation, connect a voltage to the collection unit.

Two versions of the collection unit are available:

- EVG-SA HVAC no. 4466916, product no. WU0001, EVG-SA gateway SIM card (GSM)
- EVG-EA HVAC no. 4466917, product no. WU0002, EVG-EA gateway Ethernet

2.3 Connecting the impulse sensors to the collection unit (optional)

1. Connect any impulse sensors located in the same building, such as the main water meter, to channels 1–4 in the connection table of the collection unit, see Figure 1.

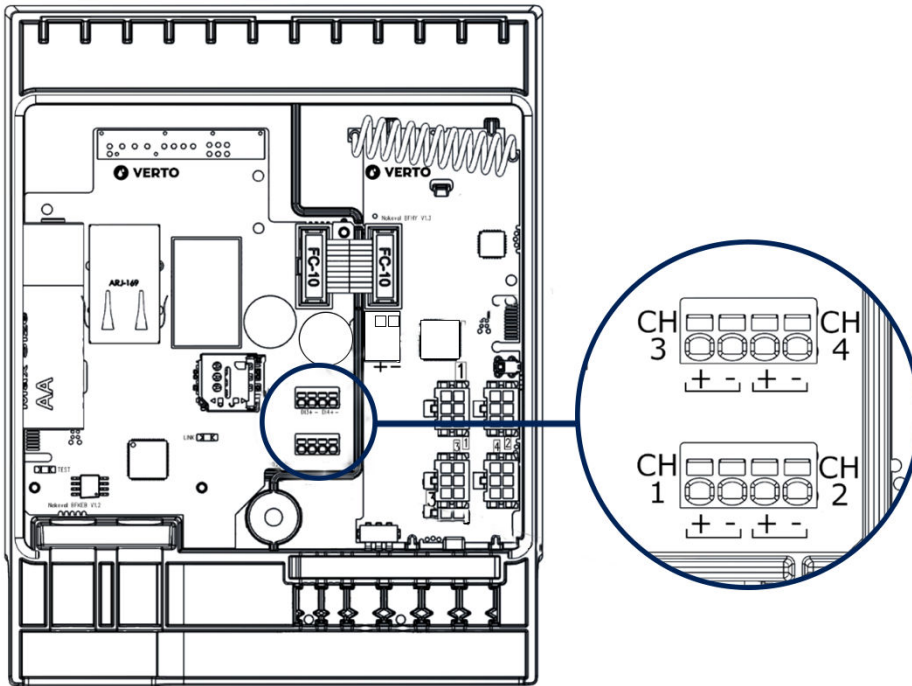

Figure 1: Channels 1–4 in the connection table of the collection unit

2. Connect the impulse input with a shielded twisted pair cable.
3. After installation, connect a voltage to the collection unit.

2.4 Installing the household unit

The household units EVH-RB are powered by a battery pack with a service life of approx. 15 years. The battery pack is replaceable, and the replacement may only be done by a maintenance provider authorised by Smartvatten. The battery pack is supplied by Smartvatten. Do not use any other type of battery pack in the equipment.

The household unit EVH-R230 is equipped with a 230 V internal power source that is connected to the mains supply. In case of power outages, the EVH-R230 has emergency batteries.

The electrical contractor must ensure that the cables are suitable for the building/apartment and meet the regulations for fire safety and electrical installations.

1. Make sure to install the household unit in the household whose number is shown on the household unit casing.
2. Do not install the household units in a position where their cable connections face upward. Other installation positions are acceptable.
3. Install the household units near the flow sensors in each household in compliance with electrical and fire safety regulations and in a manner that makes it easy to access and service the device. If service hatches are needed, their size must be at least 500 x 500 mm.
4. The flow sensors have a 1 m connecting cable. If necessary, replace the cable with a 10 m connecting cable.
5. The sensors in the household (1 to 4 sensors per household) are connected to one household unit. If more than 4 flow sensors are needed in a household, connect the extra flow sensors to a separate household unit.

Two versions of the household unit are available:

- Battery powered EVH-RB HVAC no. 4466914, product no. WU0005
- Mains power EVH-R230 HVAC no. 4466915, product no. WU0003

2.5 Connecting the flow sensors to the household unit

1. Install the flow sensor cables based on the information on the casing label (hot/cold water).
2. Install the cables in the order shown in Figure 2.

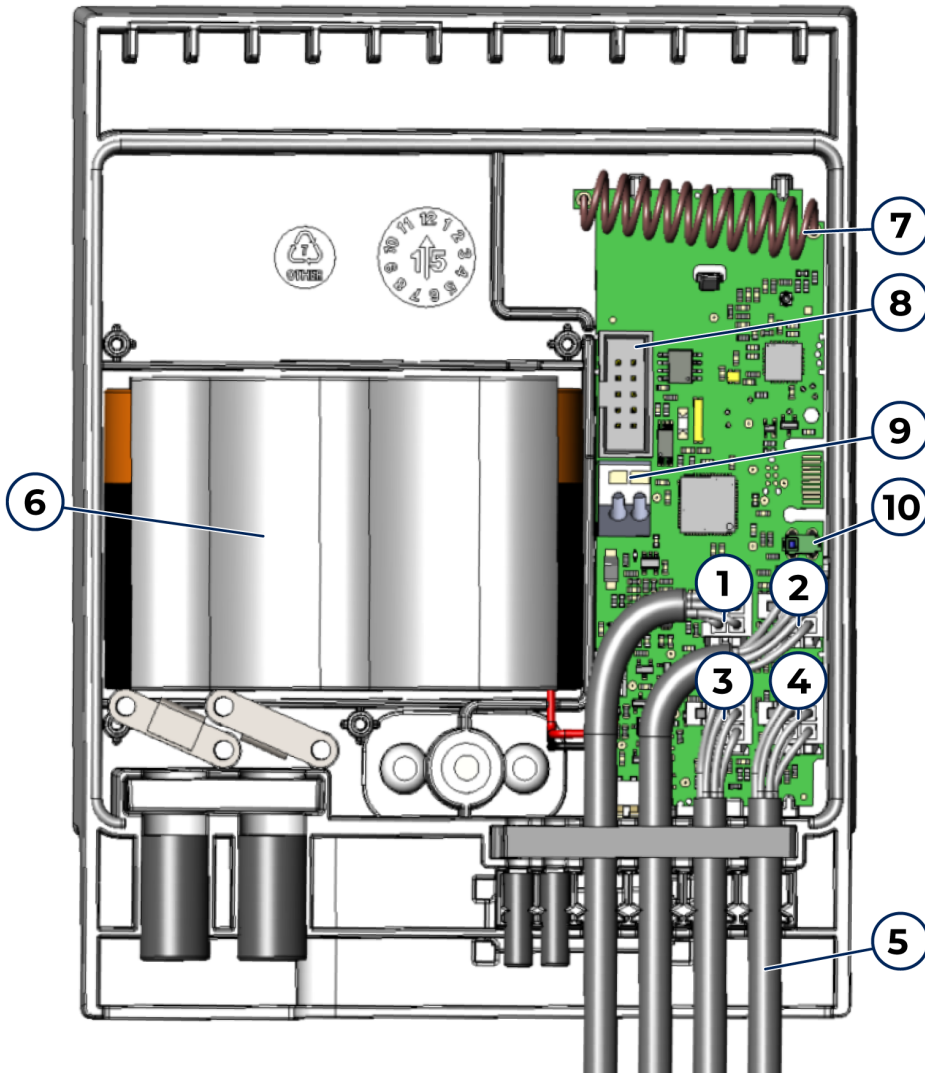

Figure 2: Installing cables to the household unit EVH-RB

1	Flow sensor cable connection	6	Battery pack
2	Flow sensor cable connection	7	Antenna
3	Flow sensor cable connection	8	Connector for additional element
4	Flow sensor cable connection	9	Connector for DC power source
5	Flow sensor cables	10	Cover switch

3. Connect both ends of the sensor cable before powering up the household unit.

4. With the EVH-R230 household unit, first install the flow sensor cables as with the battery powered household unit EVH-RB.
5. After this, install the cables.

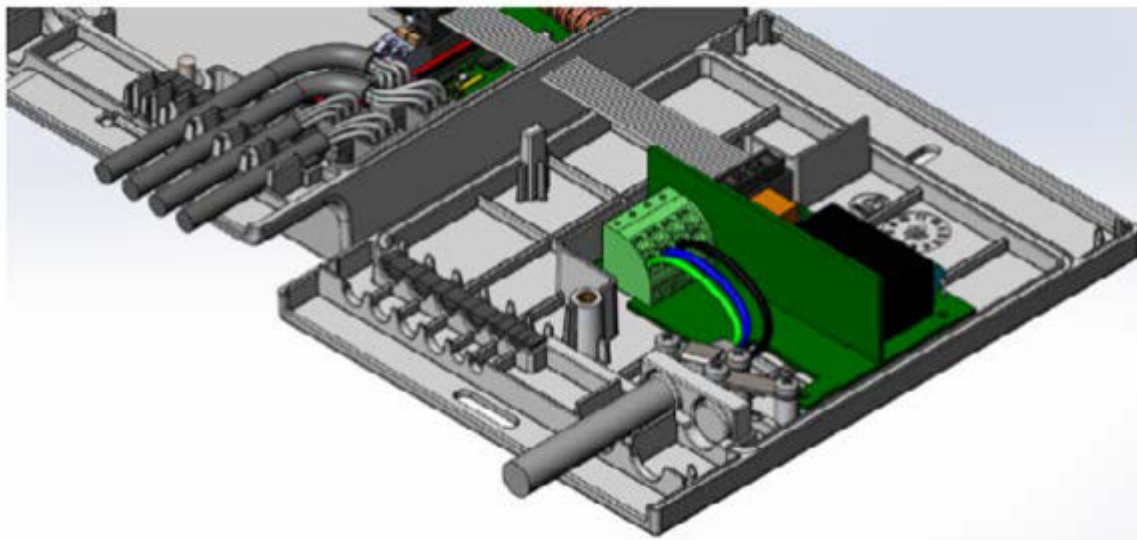

Figure 3: Installing cables to the 230 V household unit EVH-R230

6. Connect the backup battery connector to the household unit EVH-R230, or the battery pack connector to the household unit EVH-RB. Route the cables as shown in the images. Make sure that the cable does not get caught between the inner walls of the casing.

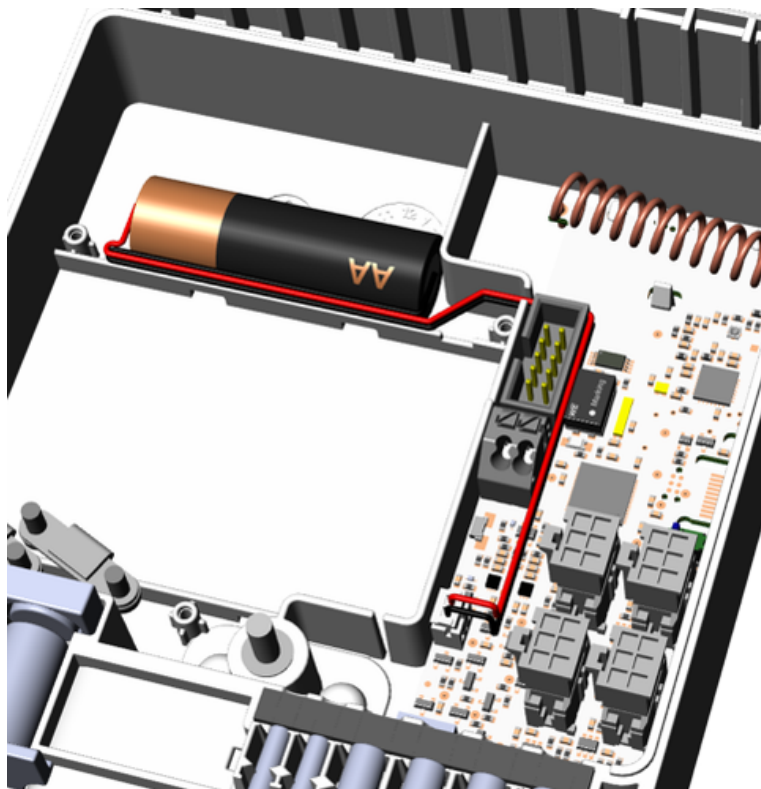

Figure 4: EVH-R230, connecting the backup battery

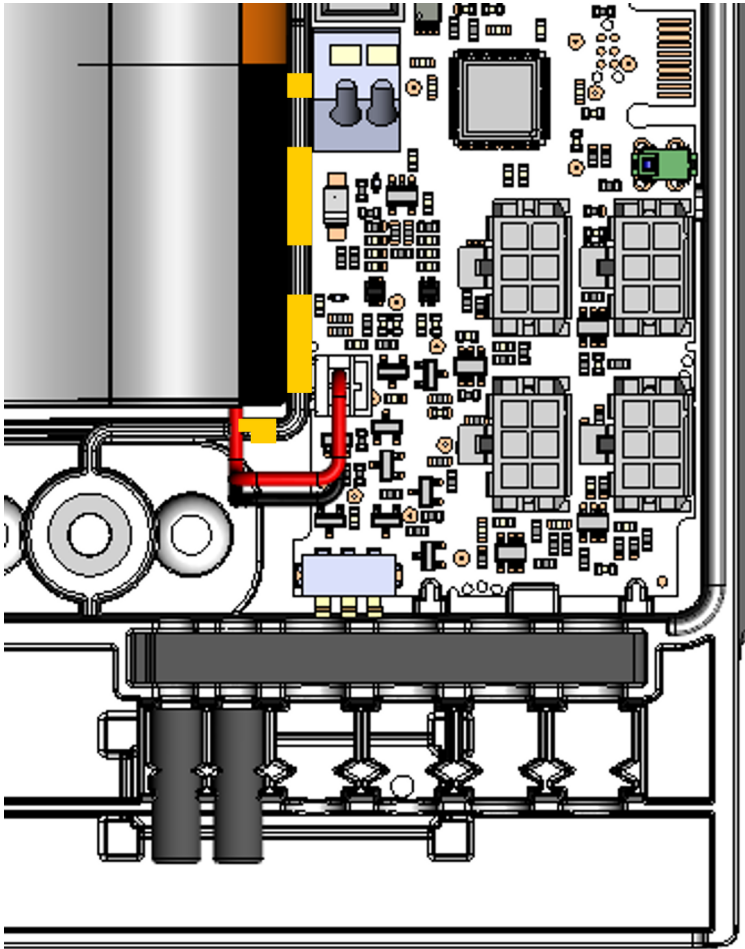

Figure 5: EVH-RB, connecting the battery pack

2.6 Installing the unit display

2.6.1 Installing the unit display EVN-RB

1. Place the unit display in a dry space using the wall mount that is included in the delivery.
2. Install the wall mount in the entryway or hallway. The recommended installation height is 160 cm.
3. The unit display also features household temperature and humidity measuring. Take this into account when determining the installation location.
4. The unit display and the household unit are usually delivered pre-paired, and they must be installed in the space indicated on the casing label. Otherwise, inform Smartvatten of the serial number of the unit display. For the EVN-RB unit display, the pairing is done in the cloud service.
5. Install the unit display to the wall mount.



EVN-RB HVAC no. 4466934

2.6.2 Installing the unit display EVN-RC

1. Place the unit display in a dry space using the wall mount that is included in the delivery.
2. Install the wall mount in the entryway or hallway. The recommended installation height is 160 cm.
3. The unit display also features household temperature and humidity measuring. Take this into account when determining the installation location.
4. The unit display and the household unit are usually delivered pre-paired, and they must be installed in the space indicated on the casing label. Otherwise, inform Smartvatten of the serial number of the unit display. For the EVN-RC unit display, the pairing is done in the cloud service.
5. Connect the EVN-RC unit display to the 5–12 V DC power supply with a USB-C connector.
 1. For surface mounting, you can separately order the white, plug-mounted power adapter WU00064, and a 2 m long USB-C cable.
 2. For box mounting, you can separately order the power adapter WU00062, which comes with a grommet and strain relief.



More detailed electrical design instructions and examples can be found on our home pages.

3. Measure the length of the cord as shown in the figure.



4. Fasten the strain relief and the grommet of the power adapter firmly on the back of the wall mount.



6. Install the unit display to the wall mount.



EVN-RC HVAC no. 4466933

3 AFTER THE INSTALLATION

3.1 Commissioning inspection

The warranty requires an approved commissioning inspection. When installation is nearing completion, the plumbing contractor arranges the commissioning inspection procedure with the device manufacturer in good time (at least two weeks in advance).

The commissioning inspection is performed by a maintenance provider authorised by Smartvatten.

Tel. +358 20 741 4020

E-mail verto@smartvatten.fi

3.2 Service

When calling Smartvatten service, please state the serial number of your collection unit. If possible, call the service while on site.

Tel. +358 20 741 4020

3.3 Warranty

The warranty requires an approved commissioning inspection. When the commissioning inspection takes place, a representative of the plumbing contractor that installed the equipment must be present on site.

3.4 Recycling

Various parts of the system contain materials that need to be recycled as electronic waste. Our company is a member of the SELT Association and as a customer you can return your used equipment free of charge to the recycling centres for electrical and electronic waste. The location of the nearest recycling centre can be found at: www.elker.fi/fi/SER-kierratys



NOTE Do not dispose of the equipment as mixed waste.

4 TECHNICAL DETAILS

4.1 Household unit

EVH-RB HVAC no. 4466914

EVH-R230 HVAC no. 4466915

- Wireless connection to the unit display and collection unit
- LoRa radio
- EVH-RB: Battery nominal voltage 3.6 V. The service life of the Li-Th battery pack is approximately 15 years. The batteries may be replaced only by a maintenance provider authorised by Smartvatten.
- EVH-R230: Input voltage: 230 V, ~50 Hz.



4.2 Unit display

4.2.1 Unit display EVN-RB

EVN-RB, HVAC no. 4466934

- Wireless
- Mounting on wall mount
- Metering of household temperature and humidity
- Dimensions: 96.5 x 96.5 x 26.0 mm (H x W x D)
- Batteries: 2 x LR6 AA alkaline battery
- Residents can replace the batteries as necessary



Figure 6: EVN-RB, HVAC no. 4466934

4.2.2 Unit display EVN-RC

EVN-RC, HVAC no. 4466933

- Wireless data transmission
- Mounting on wall mount
- Metering of household temperature and humidity
- Dimensions: 96.5 x 96.5 x 26.0 mm (H x W x D)
- USB-C cable, 5–12 V DC power source



Figure 7: EVN-RC, HVAC no. 4466933

4.3 Flow sensor

HVAC no. 4466932

Type approval: 0402-MID-C600001

Meets the requirements for MID type approval 2014/32/EU.

- V-15U 1 m ultrasound (hot and cold domestic water)
- Nominal size: DN 15 (R ½)
- Pressure rating: PN 10
- Temperature max: 70°C
- Flow range R40
- Flow rate Q3: 1.6 m³/h
- The body is made of a durable composite (PPS)
- Non-return valve: Yes (pressure relief function, 10 bar)

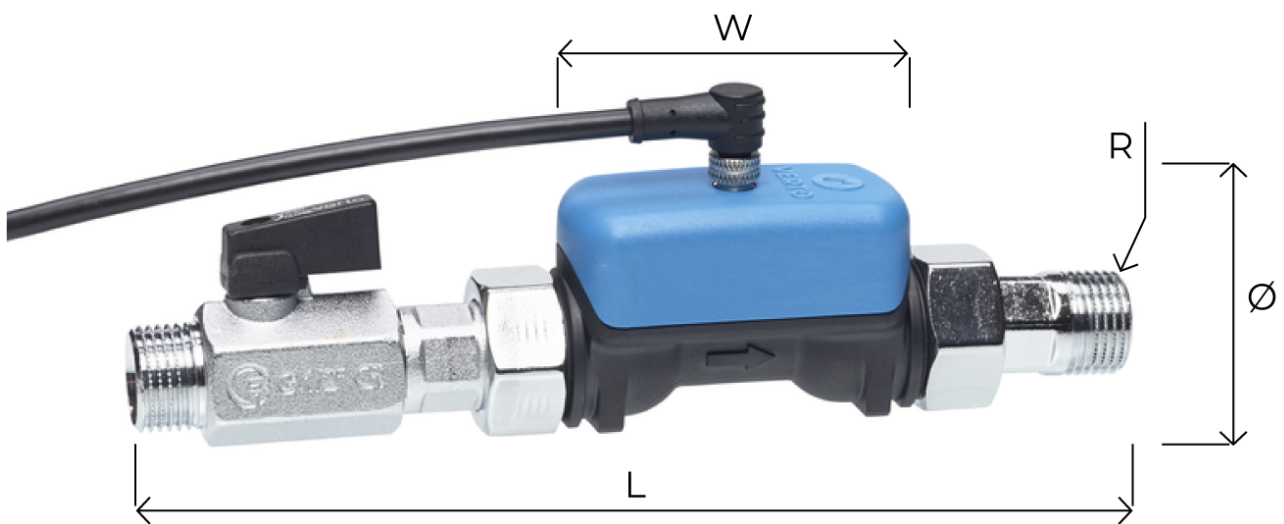

Dimensions	W	Ø	R	L
V-150	85	45 / 65	1/2"	196

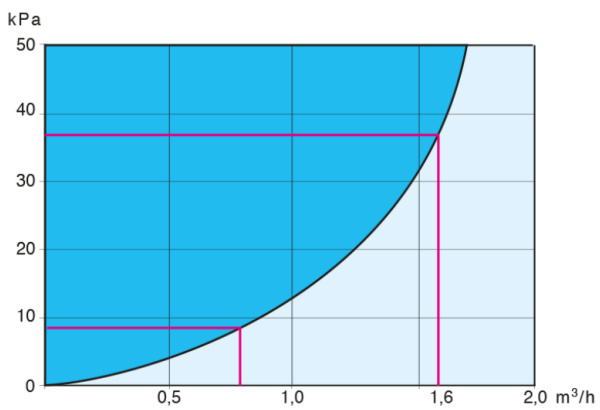

4.4 Collection unit

EVG-SA HVAC no. 4466916 / EVG-SA gateway SIM card (GSM)

EVG-EA HVAC no. 4466917 / EVG-EA gateway Ethernet

- Capacity: consumption data from 300 household units
- LoRa radio
- Mobile network with SIM card, or TCP/IP Ethernet connection
- Input voltage:
 - EVG-SA 230V, ~50Hz
 - EVG-EA 230V, ~50Hz



5 DECLARATION OF CONFORMITY



DECLARATION OF CONFORMITY VAATIMUSTENMUKAISUUSVAKUUTUS FÖRSÄKRAN OM ÖVERENSSTÄMMELSE

The Manufacturer/ VertoNordic Oy
Valmistaja/Tillverkare Jasperintie 290, FI-33960 Pirkkala

Manufacturer's certificates and applied directives: Valmistajan sertifiikaatit ja sovelletut direktiivit: <i>Tillverkarens certifikat och tillämpade direktiv:</i>			
Standard/ Directive Standardi/ Direktiivi Standard/ Direktiv	Notified Body Ilmoitettu laitos Anmält organ	Certificate no. Sertifiikaatin numero Certifikat nr	Valid Voimassa Giltig
MID 2014/32/EU module B	RISE AB, NB 0402	0402-MID-C600001, Revision 6	2030-10-16
MID 2014/32/EU module D	Inspecta tarkastus Oy, NB 0424	7223-03	2025-06-21

We hereby declare that the products detailed below have been manufactured in compliance with the above Measuring Instrument Directive 2014/32/EU. Products have EU type examination certificate according to MID. Products are manufactured according to EMC and Low Voltage Directive, harmonized standards, and normative documents OIML R49-1 and -2, WELMEC 7.2, and WELMEC CT-001. This declaration of conformity is solely on manufacturer's responsibility.

Vakuutamme, että alla mainitut tuotteet täyttävät Mittauslaitedirektiivin **2014/32/EU** vaatimukset. Tuotteilla on Mittauslaitedirektiivin mukainen EU- tyyppitarkastustodistus. Tuotteet valmistetaan EMC:n ja pienjännitedirektiivi sekä harmonisoitujen standardien ja ohjeellisten asiakirjojen OIML R49-1 ja -2, WELMEC 7.2 sekä WELMEC CT-001 mukaan. Tämä vaatimustenmukaisuusvakuutus on annettu valmistajan yksinomaisella vastuulla.

*Vi försäkrar att följande produkter har tillverkats enligt Mätinstrumentdirektivet **2014/32/EU**. Produkterna har EU-typintyget. Produkterna tillverkas enligt EMC och lågspänningsdirektivet, harmoniserade standarder och normerande dokument OIML R49-1 och -2, WELMEC 7.2 och WELMEC CT-001. Försäkran om överensstämmelse är tillverkarens ansvar.*

The Products/Tuotteet/Produkterna:

0402-MID-C600001: Flow sensor V15U (including ancillary fittings and ball valve), apartment units EVH-RB and EVH-R230, and apartment displays EVN-R, EVN-RB and EVN-RC.

Pirkkala, Finland, 15.4.2024

VertoNordic Oy

Tommi Aronen
Head of Development

smart vatten®

Customer Support

Tel. 020 741 4020 | verto@smartvatten.fi



SMARTVATTEN OY 2579363-3 | FI25793633

Tel. 020 741 4020 | info@smartvatten.com
Keilaranta 10, 02150 Espoo