



**smart  
vatten®**

**VERTO  
VERTOBLUE  
HVAC WORK SPECIFICATION  
MODEL**

**03/06/2025**

# 1 SMARTVATTEN VERTO HVAC WORK SPECIFICATION MODEL

## 1.1 Space-specific water metering

The Smartvatten Verto system, a wireless system for metering hot and cold domestic water, is installed according to the HVAC and electrical designs. The system comprises of

- space-specific flow sensors
- household units and unit displays
- a remotely readable collection unit.

Flow sensors (1–4 sensors / household unit) are installed in each household, and household units are installed near the sensors. The household units are numbered at the factory in accordance with the household numbering on the site.

The same sensor (V-15U) works on both hot and cold water lines.

The Smartvatten Verto objects are in the MagiCad product database.

## 1.2 Water metering modules

Hot and cold water connections are configured according to the needs of the installation site.

The basic system features one collection unit.

### 1.2.1 Module 1

- Metering of hot or cold water only
- One flow sensor (incl. stop valve)
- HVAC no. 4466919, product no. WUMOD1

### 1.2.2 Module 2

- Metering of hot and cold water
- Two flow sensors (incl. stop valve)
- HVAC no. 4466927, product no. WUMOD2

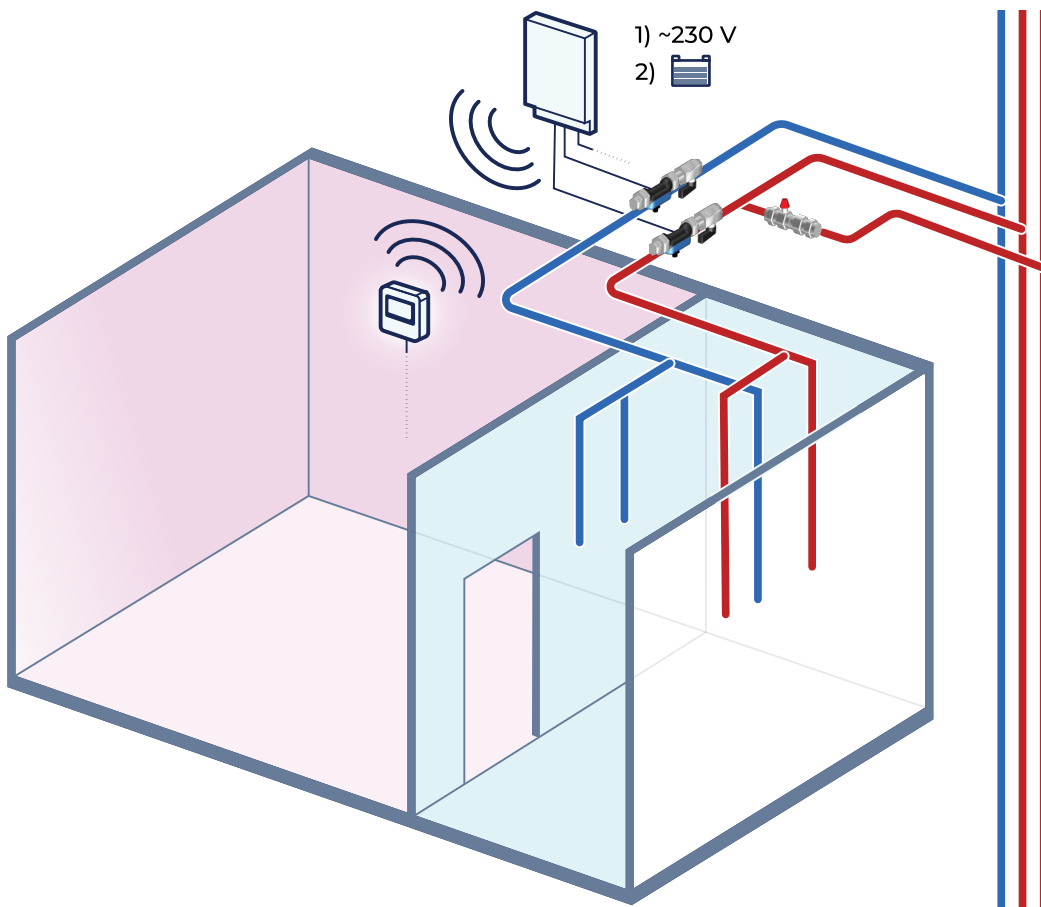

### 1.2.3 Module 3

- Metering of hot water with two flow sensors
- Metering of cold water with one flow sensor
- Three flow sensors (incl. stop valve)
- HVAC no. 4466928, product no. WUMOD3

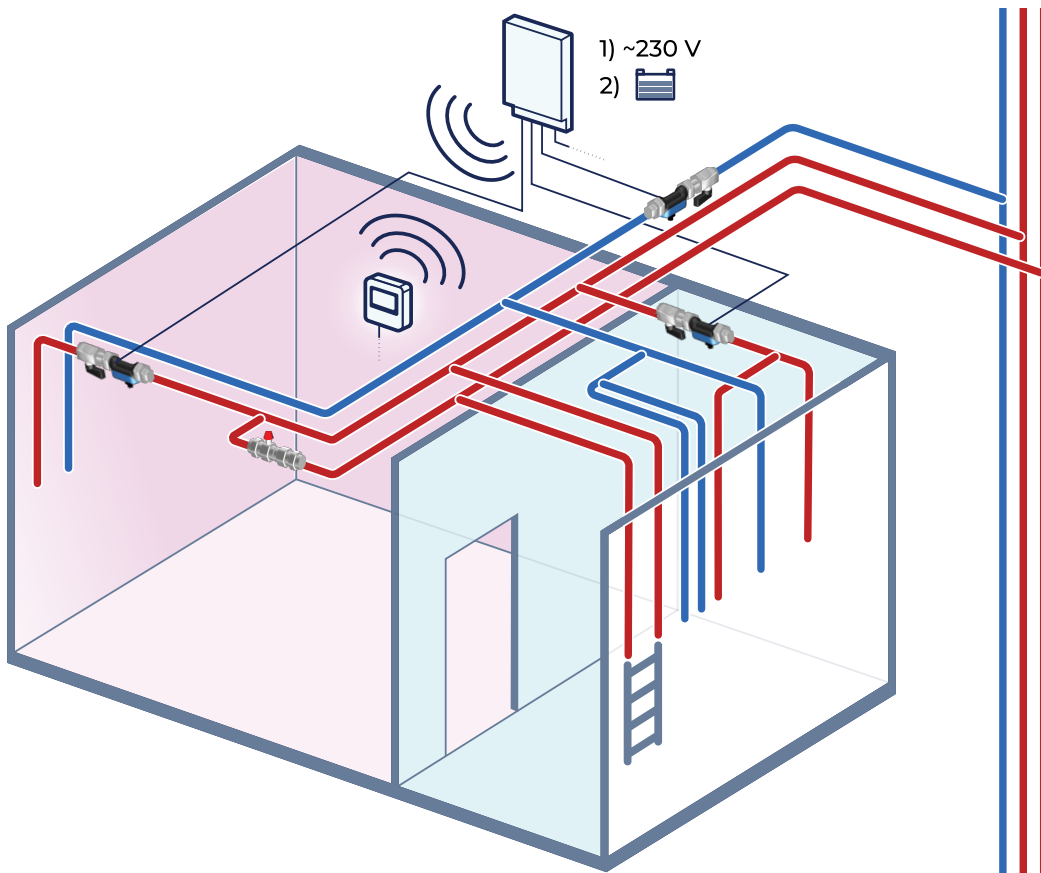

### 1.2.4 Module 4

- Two risers in the space
- Metering of hot water with two flow sensors
- Metering of cold water with two flow sensor
- Four flow sensors (incl. stop valve)
- HVAC no. 4466929, product no. WUMOD4

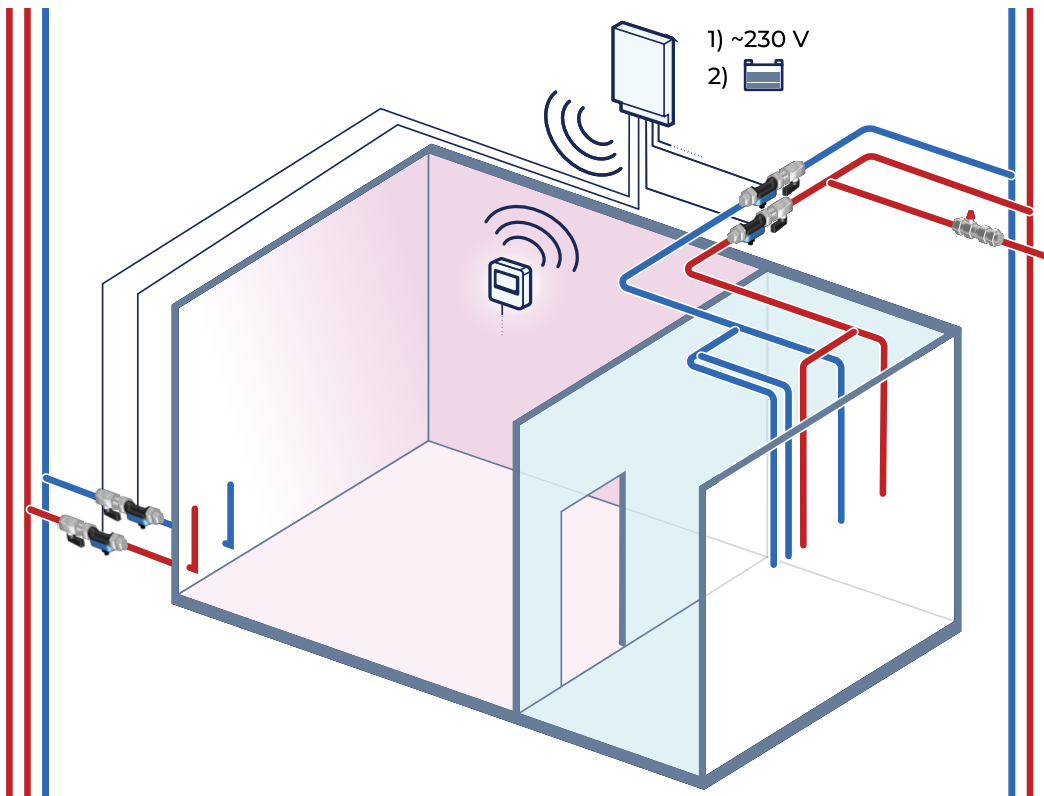

### 1.3 Unit display

#### 1.3.1 Unit display EVN-RB

EVN-RB, HVAC no. 4466934

- Mounting on wall mount
- Dimensions: 96.5 x 96.5 x 26.0 mm (H x W x D)
- Batteries: 2 x LR6 AA alkaline battery



Figure 1: EVN-RB, HVAC no. 4466934

##### 1.3.1.1 Installing the unit display EVN-RB

1. Place the unit display in a dry space using the wall mount that is included in the delivery.
2. Install the wall mount in the entryway or hallway. The recommended installation height is 160 cm.
3. The unit display also features household temperature and humidity measuring. Take this into account when determining the installation location.

4. The unit display and the household unit are usually delivered pre-paired, and they must be installed in the space indicated on the casing label. Otherwise, inform Smartvatten of the serial number of the unit display. For the EVN-RB unit display, the pairing is done in the cloud service.
5. Install the unit display to the wall mount.



EVN-RB HVAC no. 4466934

### 1.3.2 Unit display EVN-RC

EVN-RC, HVAC no. 4466933

- Wireless data transmission
- Mounting on wall mount
- Dimensions: 96.5 x 96.5 x 26.0 mm (H x W x D)
- USB-C cable, 5–12 V DC power source



Figure 2: EVN-RC, HVAC no. 4466933

#### 1.3.2.1 Installing the unit display EVN-RC

1. Place the unit display in a dry space using the wall mount that is included in the delivery.

2. Install the wall mount in the entryway or hallway. The recommended installation height is 160 cm.
3. The unit display also features household temperature and humidity measuring. Take this into account when determining the installation location.
4. The unit display and the household unit are usually delivered pre-paired, and they must be installed in the space indicated on the casing label. Otherwise, inform Smartvatten of the serial number of the unit display. For the EVN-RC unit display, the pairing is done in the cloud service.
5. Connect the EVN-RC unit display to the 5–12 V DC power supply with a USB-C connector.
  1. For surface mounting, you can separately order the white, plug-mounted power adapter WU00064, and a 2 m long USB-C cable.
  2. For box mounting, you can separately order the power adapter WU00062, which comes with a grommet and strain relief.



More detailed electrical design instructions and examples can be found on our home pages.

3. Measure the length of the cord as shown in the figure.



4. Fasten the strain relief and the grommet of the power adapter firmly on the back of the wall mount.



6. Install the unit display to the wall mount.



EVN-RC HVAC no. 4466933

## 1.4 Collection unit

Two versions of the collection unit are available:

- EVG-SA HVAC no. 4466916, product no. WU0001, EVG-SA gateway SIM card (GSM)
- EVG-EA HVAC no. 4466917, product no. WU0002 , EVG-EA gateway Ethernet

## 1.5 Household unit

Two versions of the household unit are available:

- Battery powered EVH-RB HVAC no. 4466914, product no. WU0005
- Mains power EVH-R230 HVAC no. 4466915, product no. WU0003

## 1.6 Placement of flow sensors, hot and cold water

The connectors and a stop valve are included in the delivery of the flow sensor. The connector after the sensor is equipped with an integrated non-return valve with a pressure relief function (activation pressure 10 bar).

1. Install the flow sensors into a horizontal or vertical pipe paying attention to the flow direction indication arrow on the sensor body.

The flow sensors come factory-equipped with a laminar flow equalizer. If you remove the laminar flow equalizer, install a straight cable section of 200 mm before the flow sensor.

2. Place the flow sensors so that they are easy to service. Make sure that their installation must meet the regulations for fire safety and electrical installations.
3. If you place the devices inside a casing or suspended ceiling, install a service hatch measuring at least 500 x 500 mm in the location of the devices.
4. We do not recommend installing the devices in the footings of kitchen cupboards or other cramped spaces. The cabinets under the kitchen sink must be waterproofed in case of possible leaks.

## 1.7 Connecting the flow sensors to the household unit

1. Install the flow sensor cables based on the information on the casing label (hot/cold water).
2. Install the cables in the order shown in Figure 3.

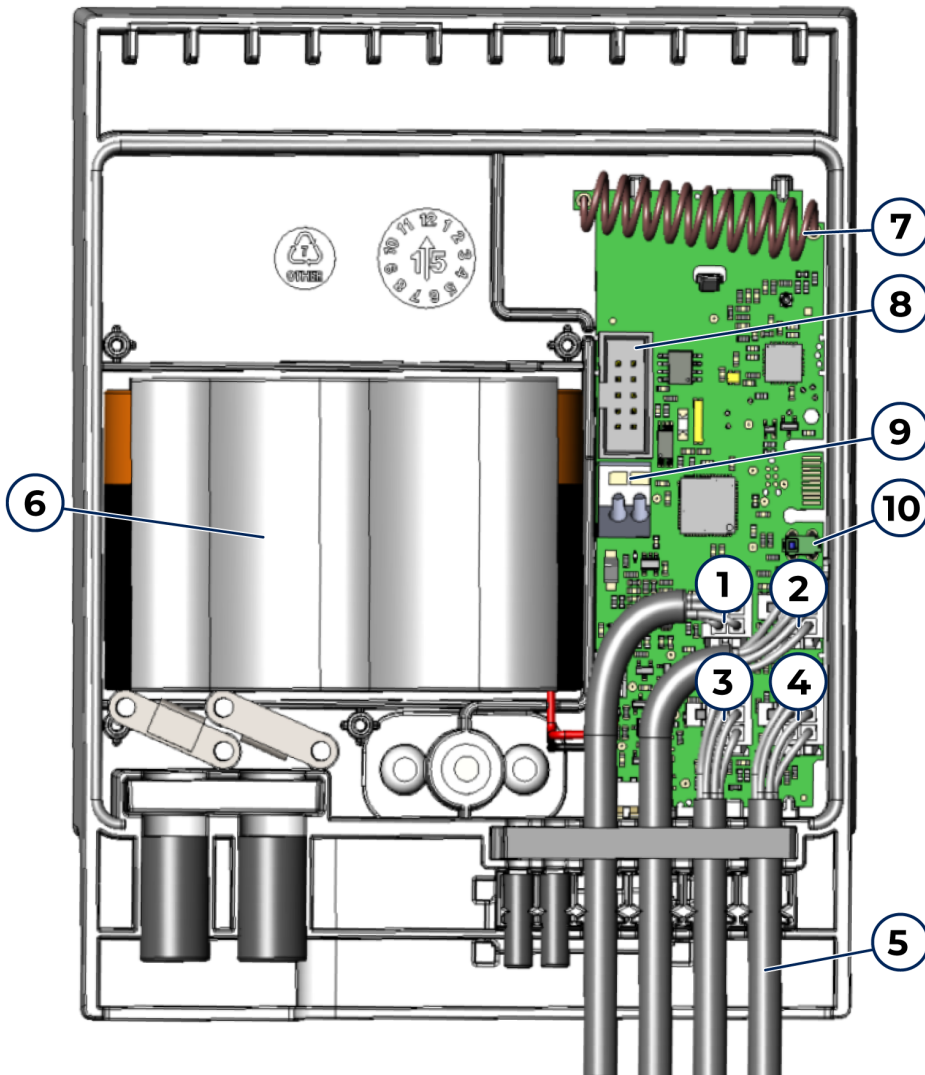

Figure 3: Installing cables to the household unit EVH-RB

- |   |                              |    |                                  |
|---|------------------------------|----|----------------------------------|
| 1 | Flow sensor cable connection | 6  | Battery pack                     |
| 2 | Flow sensor cable connection | 7  | Antenna                          |
| 3 | Flow sensor cable connection | 8  | Connector for additional element |
| 4 | Flow sensor cable connection | 9  | Connector for DC power source    |
| 5 | Flow sensor cables           | 10 | Cover switch                     |

3. Connect both ends of the sensor cable before powering up the household unit.
4. With the EVH-R230 household unit, first install the flow sensor cables as with the battery powered household unit EVH-RB.
5. After this, install the cables.

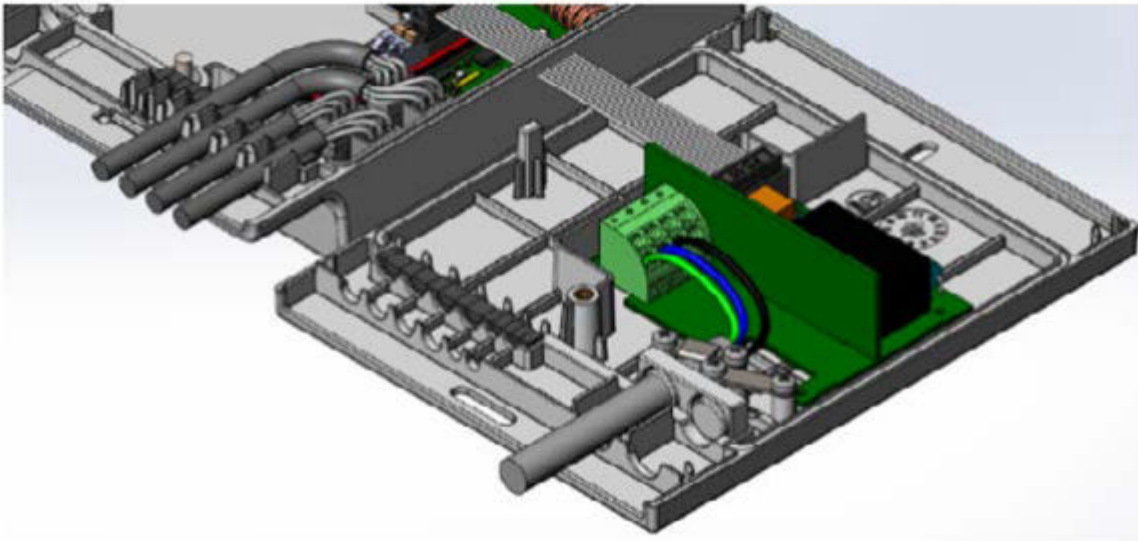

Figure 4: Installing cables to the 230 V household unit EVH-R230

6. Connect the backup battery connector to the household unit EVH-R230, or the battery pack connector to the household unit EVH-RB. Route the cables as shown in the images. Make sure that the cable does not get caught between the inner walls of the casing.

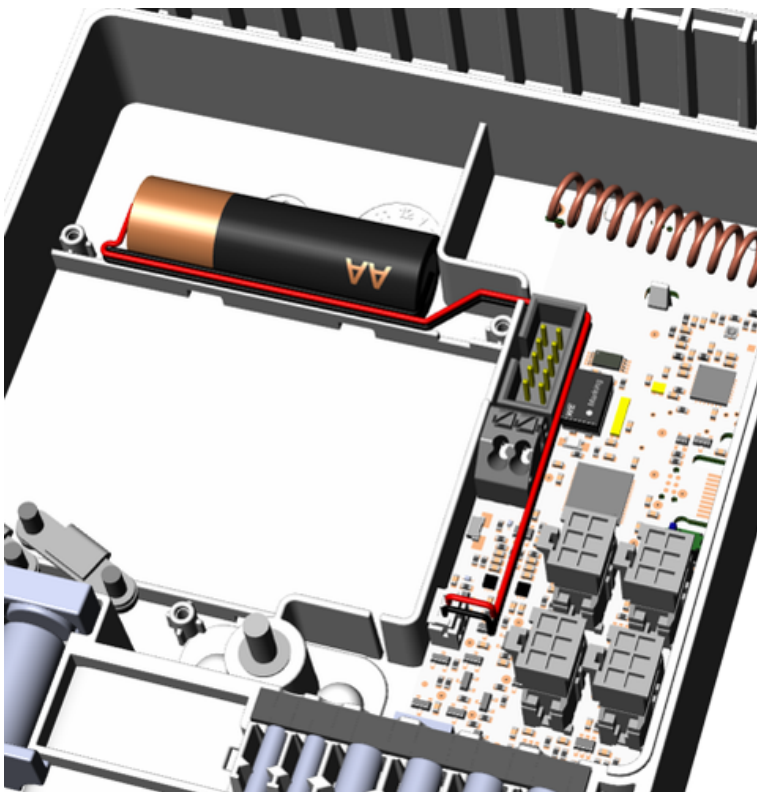

Figure 5: EVH-R230, connecting the backup battery

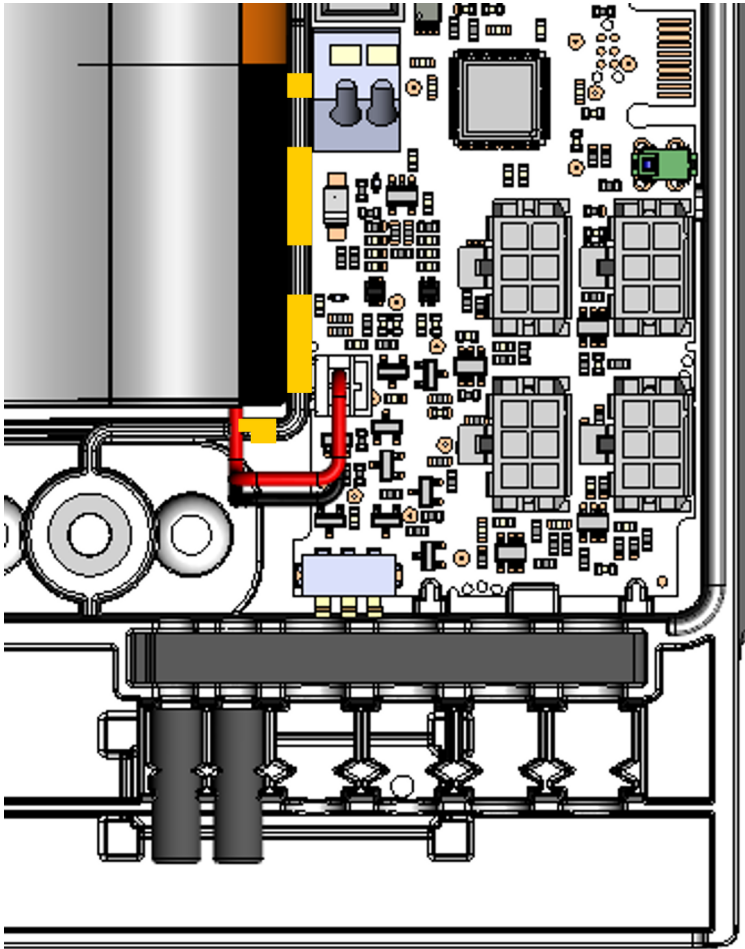

Figure 6: EVH-RB, connecting the battery pack

## 1.8 Commissioning inspection

The warranty requires an approved commissioning inspection. When installation is nearing completion, the plumbing contractor arranges the commissioning inspection procedure with the device manufacturer in good time (at least two weeks in advance).

The commissioning inspection is performed by a maintenance provider authorised by Smartvatten.

Tel. +358 20 741 4020

E-mail [verto@smartvatten.fi](mailto:verto@smartvatten.fi)

## 1.9 Duties of the HVAC contractor

The plumbing contractor acquires the flow sensors, household units, unit displays and collection unit and installs the flow sensors.

The battery-powered system may be installed by persons who do not hold an electrical installation license.

## 1.10 Duties of the construction contractor

The construction contractor must make sure that an easily accessible service hatch, measuring at least 500 mm x 500 mm, is provided in the location of the flow sensors and household unit.

## 1.11 Duties of the electrical contractor

- Installing the household units and collection units and, as agreed separately, connecting them to the electricity network (the household units are numbered at the factory in accordance with the household numbering on the site).
- Installing the necessary cabling, and installing and connecting the household units, unit displays and their wall mounts and the collection units in accordance with the electrical designer's instructions.
- Where necessary, installing an electrical socket for the collection unit.

Battery-powered household units (EVH-RB) may be installed by persons who do not hold an electrical installation license.

## 1.12 Duties of the property developer

Contacting the device manufacturer to connect the site for Smartvatten Flex reading in collaboration with the property manager.

## 1.13 Duties of the property manager

Reading the water metering data remotely requires a valid data service agreement.

For more information, contact our customer service.

Tel. +358 20 741 4020

E-mail [verto@smartvatten.fi](mailto:verto@smartvatten.fi)

## 1.14 Appendix to the building's maintenance book

The battery-powered household unit option features a replaceable lithium thionyl battery pack with a service life of up to 15 years. Only use a battery pack supplied by Smartvatten to power the devices. The batteries may be replaced a maintenance provider authorised by Smartvatten.

The unit display is powered with two AA alkaline batteries that can be replaced by the resident.

Meter readings and status data are monitored regularly by remote reading on VertoLive. Water consumption data for billing purposes is easily available on the VertoLive cloud service.

# smart vatten®

## Customer Support

Tel. 020 741 4020 | [verto@smartvatten.fi](mailto:verto@smartvatten.fi)



---

SMARTVATTEN OY 2579363-3 | FI25793633

Tel. 020 741 4020 | [info@smartvatten.com](mailto:info@smartvatten.com)  
Keilaranta 10, 02150 Espoo